



KEY BENEFITS

- Wedge ThoughtBoard Slim forms part of Luxxbox's agile whiteboard range
- Superior quality ceramic steel surface for streak-free writing
- Choice of laminate backing
- Use multiple ThoughtBoards to create a straight or curved room divider
- High quality lockable castors for ease of movement, concealed to remove trip hazard
- Ships flat, easy to assemble, short lead times
- Magnetic surface hosts a suite of collaborative accessories
- Non-magnetic option available
- Optional noise-absorbing acoustic panel that doubles as a pinboard
- Pinboard available in Motif collection
- All versions include internal shelf
- Only GECA certified agile whiteboard on the market

ORDER CODE

EXAMPLE: LX - WTS - YM - W - B

(Luxxbox Wedge ThoughtBoard Slim, Magnetic, White, Black Edges)

LX - WTS	MAGNETIC		INTERIOR COLOUR		EDGE COLOUR	
PRODUCT CODE	YM	Yes	O	Oak Veneer	B	Black
WTS	NM	No*	B <td>Black Veneer <td>W <td>White</td> </td></td>	Black Veneer <td>W <td>White</td> </td>	W <td>White</td>	White
			W	White		

(*Warranty terms for non-magnetic option differs from magnetic)

EXAMPLE: LX - WTX - PH

(Luxxbox Wedge ThoughtBoard Accessory, Pen Holder)

EXAMPLE: LX - WTX - SL - BY

(Luxxbox Wedge ThoughtBoard Accessory, Large Acoustic Board, Bright Yellow color)

LX - WTX	OPTIONAL ACCESSORIES		OPTIONAL ACCESSORIES	
PRODUCT CODE	FS	Flip Chart Bracket (Slim)	SS	Small Acoustic Board***
WTX	PH	Pen Holder**	SL	Large Acoustic Board***
	BT	Base Tray		
	ES	External Shelf**		

(**Pen Holder and External Shelf are only available for the Magnetic option)

(*** To Specify Acoustic Board color use color codes below)

SIZE

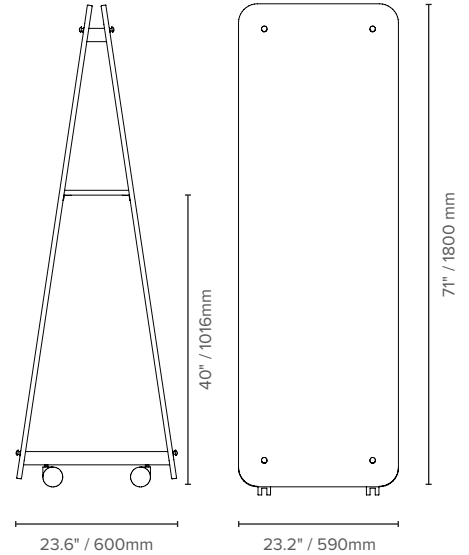

AVAILABLE COLOURS

Colors are subject to lead times and variations across batches



ACOUSTIC BOARD COLOUR





ACCESSORIES

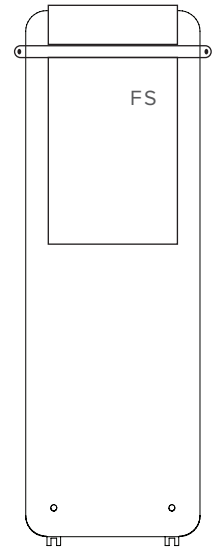
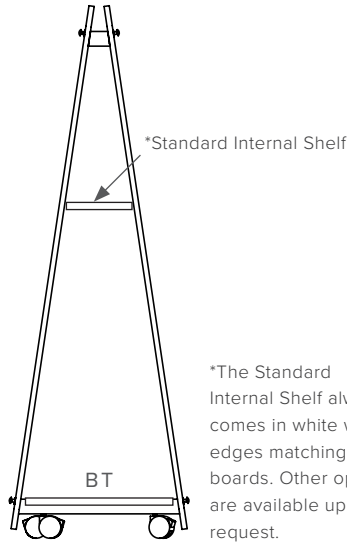
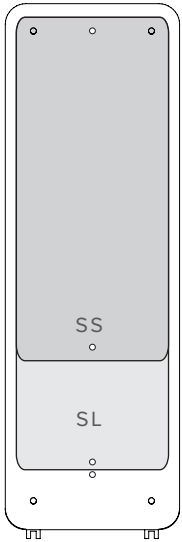

*The Standard Internal Shelf always comes in white with edges matching the boards. Other options are available upon request.

(SS) SMALL PIN BOARD

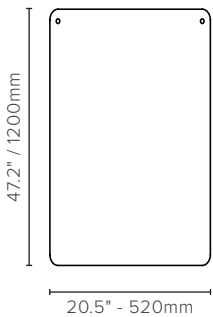

(SL) LARGE PIN BOARD

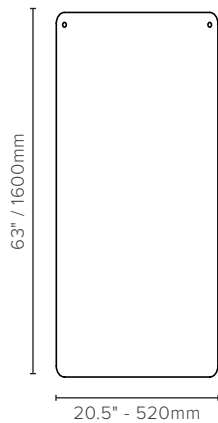

(FS) FLIP CHART BRACKET

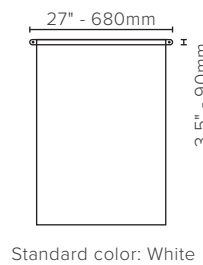

(PH) PEN HOLDER

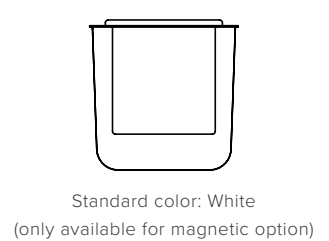

(ES) EXTERNAL SHELF

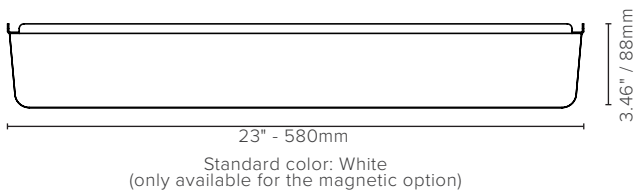

(BT) BASE TRAY

